



# SM6291-BCE-S-050-000 Gauge Pressure Sensor

The SM6291-BCE-S-050-000 is a 16-bit digital & analog, low pressure MEMS sensor offering state-of-the-art pressure transducer technology and CMOS mixed signal processing technology to produce a gauge, fully conditioned, multi-order pressure and temperature compensated sensor in JEDEC standard SOIC-16 package with dual vertical ports. The complete datasheet (40DS6860) and I2C Application Note (40AN7000) will be also available by contacting SMI Sales at (408) 577-0100 or [sales@si-micro.com](mailto:sales@si-micro.com).

Part number SM6291-BCE-S-050-000 is shipped in sticks and part number SM6291-BCE-T-050-000 is shipped in Tape and Reel.

## Sensor Specification

All parameters are specified at VDD = 3.3 V DC supply voltage at 25°C, unless otherwise noted.

No.	Characteristic	Symbol	Minimum	Typical	Maximum	Units
1	Supply Voltage	VDD	3.0	3.3	3.6	V
2	Supply Current	IDD		4.5		mA
3	Calibration Pressure	$P_{MIN} / P_{MAX}$	0		50	mBar
4	Compensated Temperature	$T_{COMP}$	-20		85	°C
5	Digital Pressure Output @ $P_{MIN}$	$DOUT_{MIN}$		-26214		Counts
6	Digital Pressure Output @ $P_{MAX}$	$DOUT_{MAX}$		26214		Counts
7	Digital Full Scale Span	DFS		52428		Counts
8	Resolution (Digital Output)			16		Bits
9	Update Rate			2000		S/sec
10	Bandwidth	BW		125		Hz
11	Digital Output Accuracy	DACC	-1		+1	%FS
12	Analog Pressure Output @ $P_{MIN}$	$AOUT_{MIN}$		10		%VDD
13	Analog Pressure Output @ $P_{MAX}$	$AOUT_{MAX}$		90		%VDD
14	Analog Full Scale Span	AFS		80		%VDD
15	Analog Output Accuracy	AACC	-1.5		+1.5	%FS

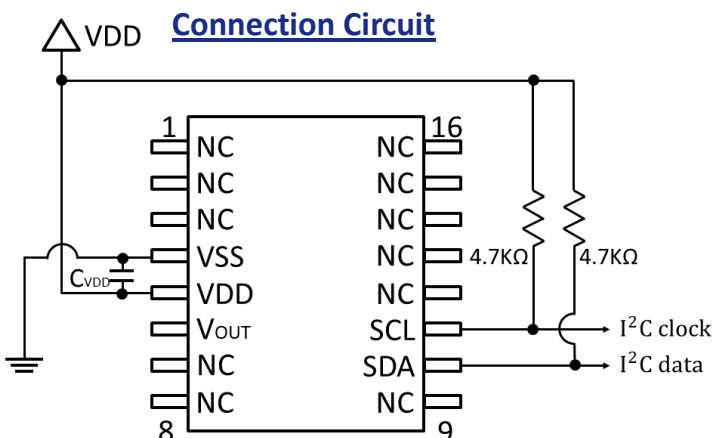

## Pinout table

Pin No.	Pin function	Pin No.	Pin function
1	NC	9	NC
2	NC	10	SDA
3	NC	11	SCL
4	VSS	12	NC
5	VDD	13	NC
6	VOUT (analog output)	14	NC
7	NC	15	NC
8	NC	16	NC

\*For package dimension information, please refer to the complete datasheet.