



SM7291-BCE-S-020-000 Gauge Pressure Sensor

The SM7291-BCE-S-020-000 is a 16-bit digital & analog, low pressure MEMS sensor combining state-of-the-art pressure transducer technology with CMOS mixed signal processing technology. This is a gauge, fully conditioned, multi-order pressure and temperature compensated sensor in JEDEC standard SOIC-16 package with dual vertical ports. The complete datasheet (40DS7860) and I2C Application Note (40AN7000) will be available by contacting SMI Sales at (408) 577-0100 or sales@si-micro.com.

Part number SM7291-BCE-S-020-000 is shipped in sticks and part number SM7291-BCE-T-020-000 is shipped in Tape and Reel.

Sensor Specification

All parameters are specified at VDD = 3.3 V DC supply voltage at 25°C, unless otherwise noted.

No.	Characteristic	Symbol	Minimum	Typical	Maximum	Units
1	Supply Voltage	VDD	3.0	3.3	3.6	V
2	Supply Current	IDD		4.5		mA
3	Calibration Pressure	P_{MIN}, P_{MAX}	0		20	mBar
4	Compensated Temperature	T_{COMP}	-20		85	°C
5	Digital Pressure Output @ P_{MIN}	$DOUT_{MIN}$		-26214		Counts
6	Digital Pressure Output @ P_{MAX}	$DOUT_{MAX}$		26214		Counts
7	Digital Full Scale Span	DFS		52428		Counts
8	Resolution (Digital Output)			16		Bits
9	Update Rate			2000		S/sec
10	Bandwidth	BW		125		Hz
11	Digital Output Accuracy	DACC	-1		+1	%FS
12	Analog Pressure Output @ P_{MIN}	$AOUT_{MIN}$		10		%VDD
13	Analog Pressure Output @ P_{MAX}	$AOUT_{MAX}$		90		%VDD
14	Analog Full Scale Span	AFS		80		%VDD
15	Analog Output Accuracy	AACC	-1.5		+1.5	%FS

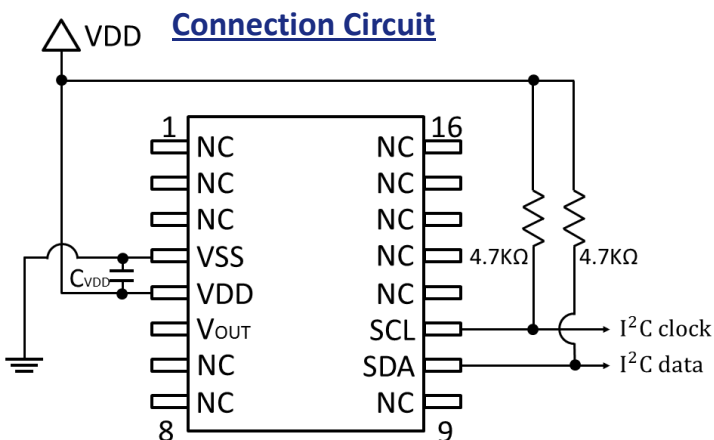

Pinout table

Pin No.	Pin function	Pin No.	Pin function
1	NC	9	NC
2	NC	10	SDA
3	NC	11	SCL
4	VSS	12	NC
5	VDD	13	NC
6	VOUT (analog output)	14	NC
7	NC	15	NC
8	NC	16	NC

*For package dimension information, please refer to the complete datasheet.